

BARGE No. 25

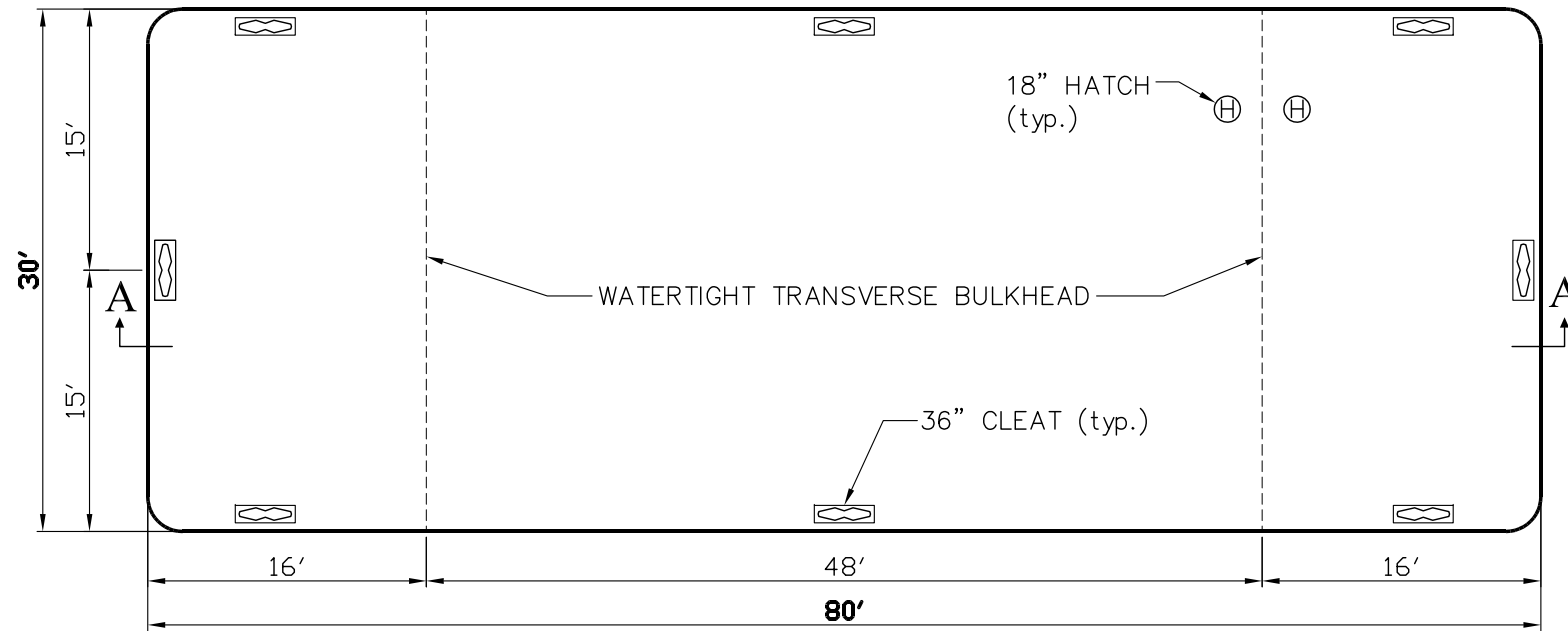

DECK PLAN

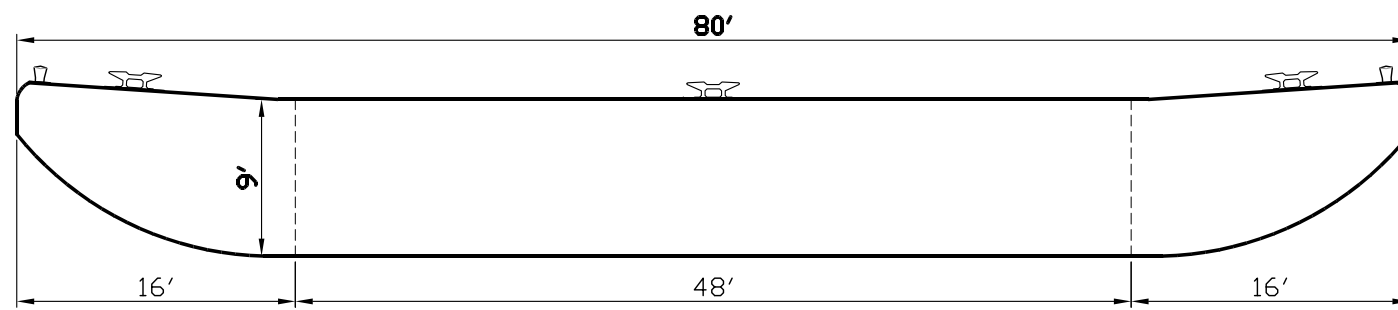

SECTION A-A

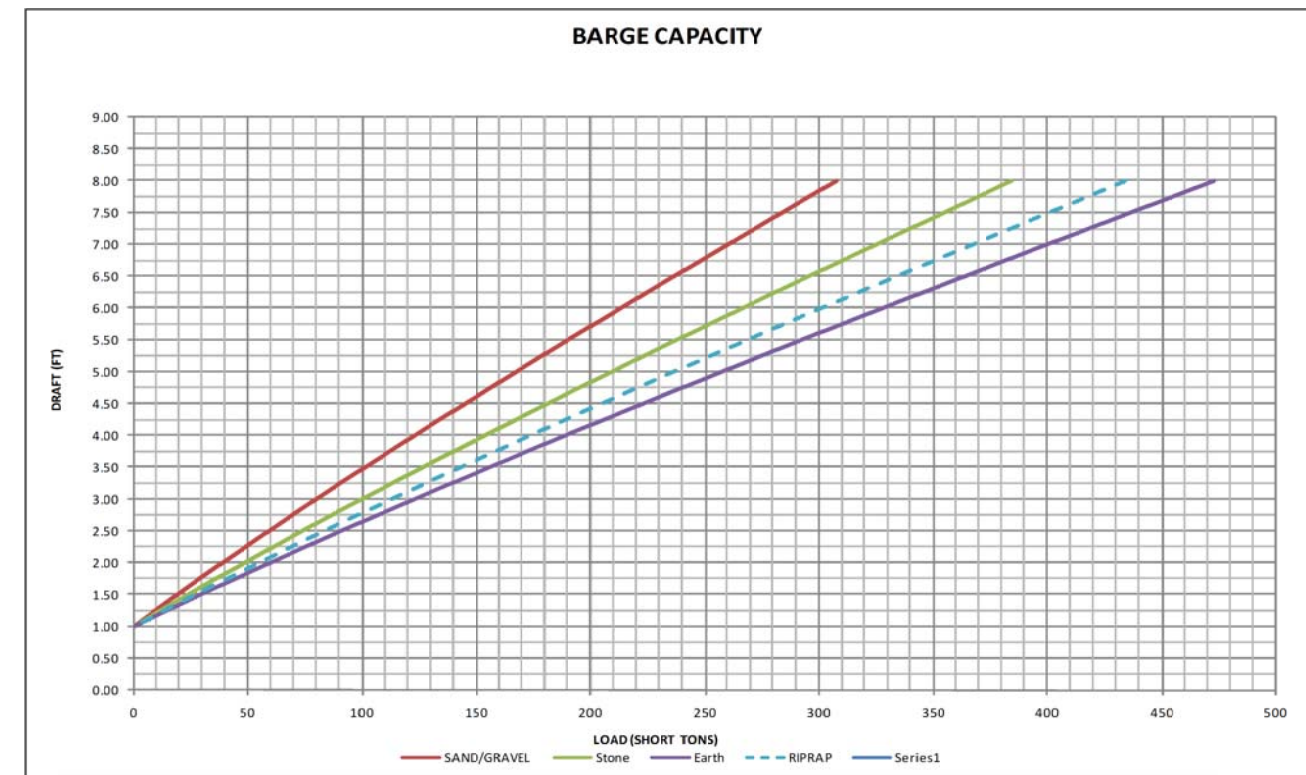

TYPE:	DECK BARGE				DESIGNER	
LENGTH:	80'				DRAFTER	
BEAM:	30'				EA	
DEPTH:	9'-0"				CHECKED	
BULKHEADS:	(2) TRANSVERSE				DATE	
CAPACITY:	SEE CHART				APPROVED	
		REV.	DESCRIPTION	DR.	APPR.	DATE

MOHAWK
NORTHEAST, INC.
170 CANAL ST. P.O. BOX 37
PLANTSVILLE, CT 06479-0037

NAME OF PROJECT:	BARGE No. 25	SCALE:	AS NOTED
DRAWING TITLE:		DATE:	08-19-09
		DRAWING NUMBER:	1